



# Manual



## RSS Roof Shelter edge protection for sloping roofs

Complying with European Norm EN 13374



**WARNING** All instructions in this manual must be strictly followed. Not following of the instructions in this manual may result in serious injury accidents. RSS Roof cannot be held liable for damage resulting from failure build in accordance with the manual and by using (in combination) non-original RSS Roof Parts and components!

# Set-up & use of the RSS Roof Shelter

A	Purpose of the RSS Shelter System & Safety instructions	2 - 3
B	Components of the RSS Shelter System	5
C	Installing and Dismantling RSS Shelter System	6 - 9

## Revision log & Notes

Revision log  
Notes

10

## Accessories RSS Roof Shelter

RSS Sloping Roof System  
Corner Protection  
Transportframe

11



# One system for different types of Roofs

According to European directives, you are required to create a safe workplace, for instance with roof edge protection on sloping roofs. The Roof Shelter is a collective safety system to enclose a work area at end facades.

The RSS Roof shelter system is a tested and TUV certified system according EN 13374:2013 class A; tested under the circumstance 10 – 50 degrees.

## SAFETY INSTRUCTIONS



Before starting assembly and disassembly work, first read the safety instructions below carefully and follow all instructions exactly. If the Roof Shelter is not installed correctly, this can lead to dangerous situations that could lead to accidents and injury.



Roof Safety Systems cannot be held liable for any direct or consequential damages of a personal, material of financial nature.

- Have at least 2 people to install the roof edge protection. These people must be familiar with the product, competent in good physical and mental condition.
- Use work gloves, safety footwear, hard hat and fall protection.
- First check that all the components are present and in good condition. Damaged and/or incorrect components may not be used!
- Only place the roof edge protection on a sloping roof and sufficiently strong base that can support the full weight of the complete system.
- Cordon off the work area from any passers-by and traffic.
- As soon as the wind force measured locally is higher than Beaufort 6, installation work must be halted.
- Never do anything to endanger the strength and stability of the roof edge protection. Do not use mechanical lifting equipment or personal fall protection on or attached to the roof edge protection.
- Always replace worn or damaged parts immediately. Contact the dealer or supplier about this.
- Do not use the system on wet roofs frozen by frost. Ice formation may cause the roof edge protection to slide.



### Ridge protection

The Roof Shelter system provides roof edge protection for pitched roofs from 10 to 50 degrees. The RSS Roof Shelter system can be used in conjunction with the RSS Sloping Roof system. When both systems are applied correctly, full collective fall protection can be realised.



Roof edge protection for sloping roofs from 10 to 50 degrees inclination

## B Components of the RSS Roof Shelter

The RSS Roof Shelter system consists of the following components

**PN 301 - Ridgehook (3,5 kg)**

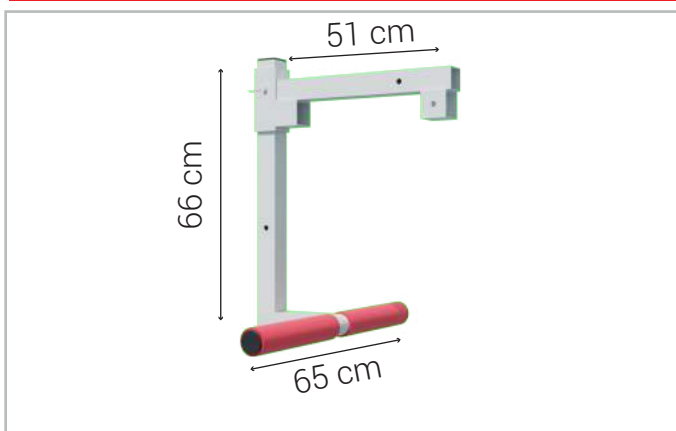

**PN 302 - Fence 3 meter (16,5 kg)**

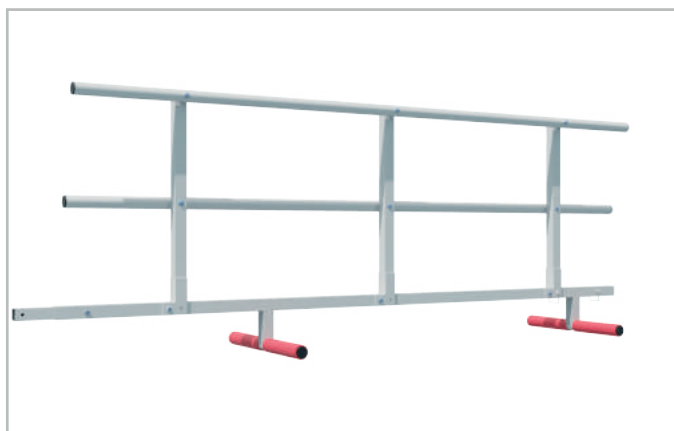

**PN 303 Fence 2 meter (12,4 kg)**



**PN 304 - Roof bracket (2,5 kg)**

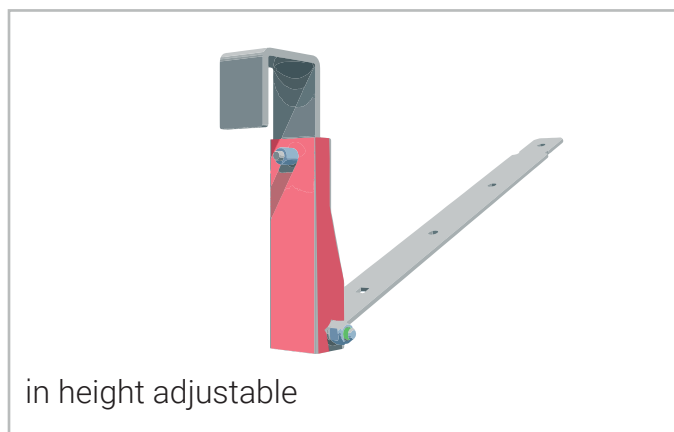

**RSH001 -Locking pin square (0,7 kg)**



**Transportframe (24 mtr) (157 kg)**

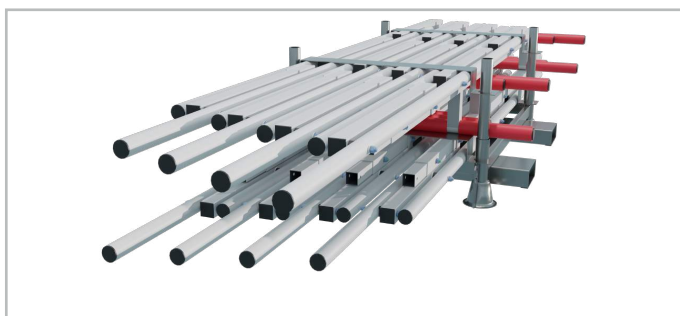

## C Installing and Dismantling the RSS Roof Shelter system



**Pay attention during assembly!**

The red beams (currently blue highlighted) should be completely on the roof.

**Correct assembly: The roof beams do lie fully on the roof.**

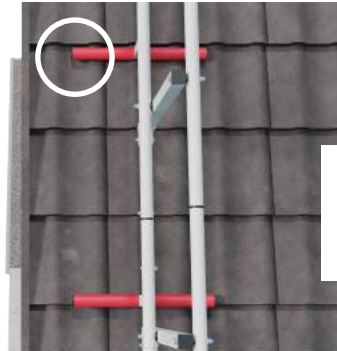
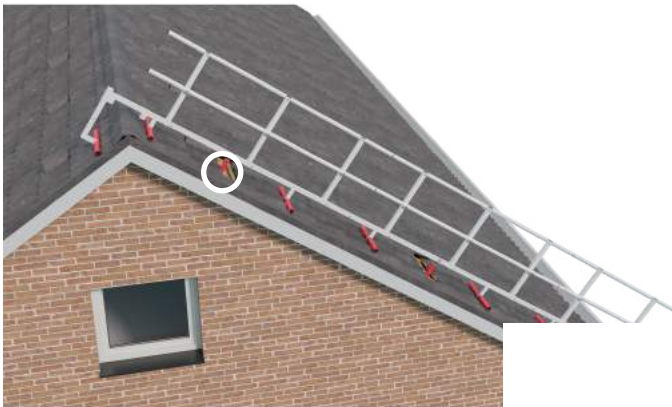

**Wrong assembly: The roof beams are NOT fully on the roof.**



## C Installing and Dismantling the RSS Roof Shelter system

### Installation Roof Shelter

**A** Connect the ridge hook to the fencing, secure it (figure 1.1) and hang it over the ridge.

Figure 1

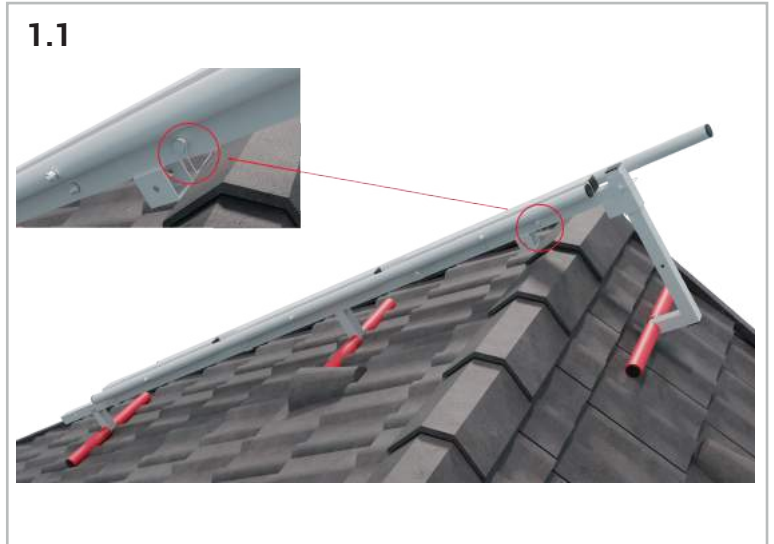

**B** Then pull the fencing back and secure it. See figure 2.1.

Figure 2

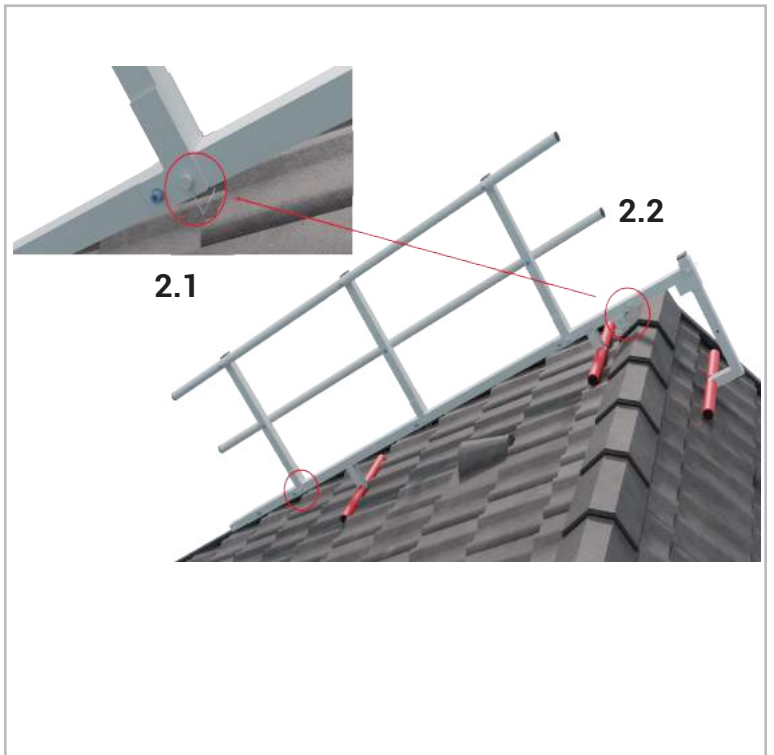

## C Installing and Dismantling the RSS Roof Shelter system

C Fasten the roof bracket and screw it securely in place with 4 wood thread bolts to a sound base (for example a purlin). Orient this bracket into your work area.

Figure 3

3.1 Height adjustable bracket



3.2 Bracket on the fencing



3.3 Mount bracket fixed to base

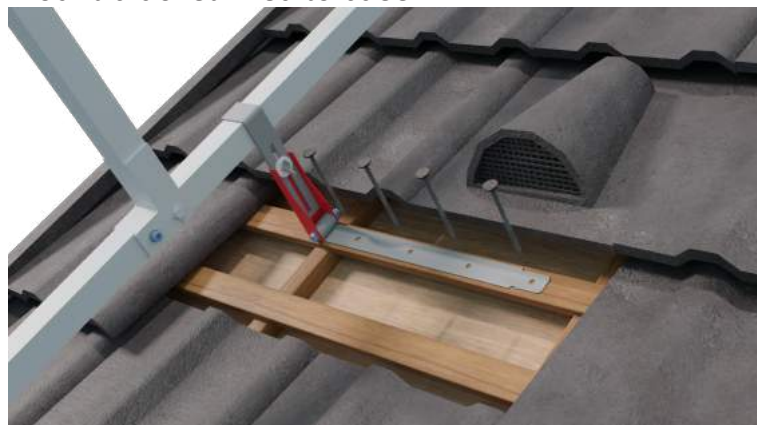



## C Installing and Dismantling the RSS Roof Shelter system

D The next fence section can now be connected and secured, see figures 4, 4.1 and 4.2 for securing.

Then repeat step C. for securing the roof bracket.

In this way, the system can be built indefinitely.

Figure 4

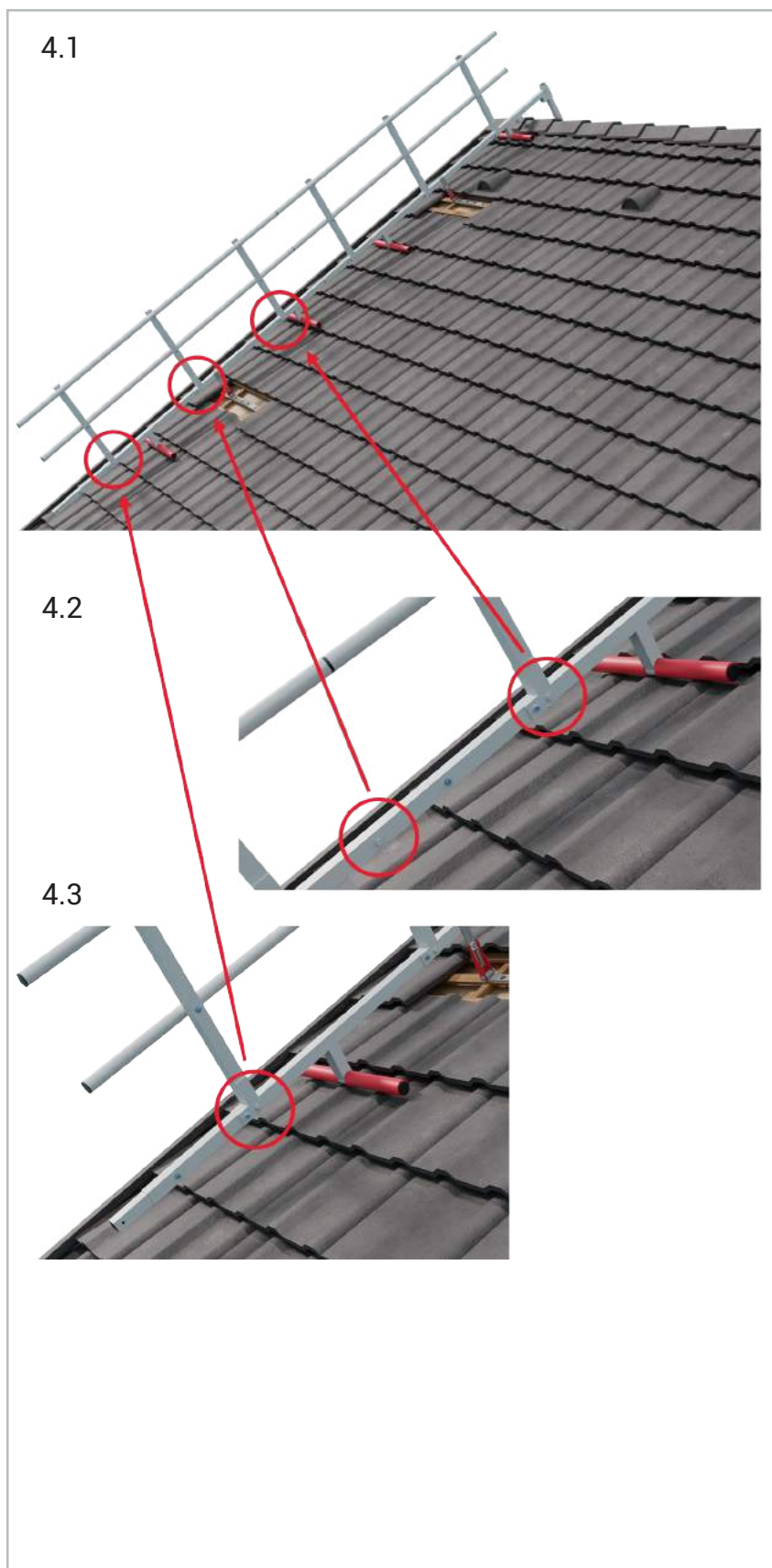

E Disassembly takes place in the reverse order of assembly



# Accessories RSS Roof Shelter hellend dak

For more information, see our website

## RSS Roof Sloping Roof System

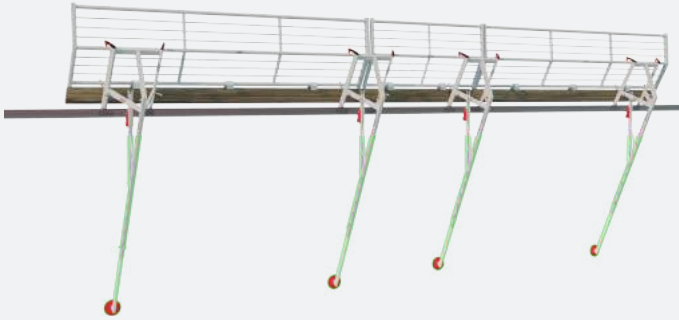

## RSS Roof Shelter Transportframe

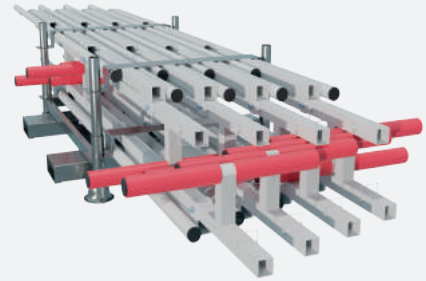

## RSS Roof Shelter Transportframe

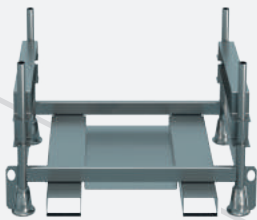

## RSS Cornerprotection



**ON A MISSION FOR  
YOUR SAFETY**